

ABI COOLING COT LINER

Step-by-step instructions for making a cot liner with neat, straight valance edges using 3 pieces of fabric, a sewing machine and straight line stitching.

MATERIALS

- 1.25 m lightweight 100% cotton fabric, approximately 115cm wide*
- Thread
- Scissors
- Tape measure
- Pencil
- Pins/ clips/ clothes pegs - whatever you have to hold pieces of fabric together
- Iron and ironing board/ mat
- Sewing machine



If you are buying fabric for this project we recommend purchasing from:

www.woolwarehouse.co.uk

- Kingfisher Fabrics - Premium Muslin - Natural (44/112cm)" or
- Rose & Hubble - Craft Cotton Solids - Natural Seeded (05)
- Gutermann Sew-all Thread 100m - Shade 414

For 10% off use discount code - CHARITY

*NOTE

Opt for 112cm wide as, including selvedge, this is the width needed for the largest pattern piece without additional cutting of the sides for this piece.

Fabric of 112cm wide will be somewhere between 113cm and 115cm total width when the non-fraying edge (selvedge) is included depending on the brand.

As long as your fabric, bought or already owned, is at least 113cm wide this will be fine as the liner is designed to overhang the edges of the Abi Cooling Cot.

INSTRUCTIONS

Give fabric a quick iron if there are any big creases, this will make marking out and cutting the pieces easier.

Lay fabric on flat surface with selvedges to the left and right, WRONG SIDE up facing you (if both sides are identical then the side you can see will be termed the wrong side; novice stitchers may wish to mark a 'W' lightly in pencil as a reminder.)

Cut 3 pieces of fabric as follows:

Piece 1 - 115cm* wide by 70cm deep

(*approximately as per NOTE in MATERIALS list)

Pieces 2 and 3 are identical - 45cm wide x 45cm deep

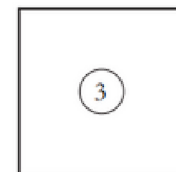
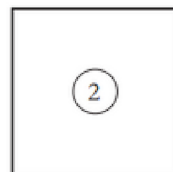
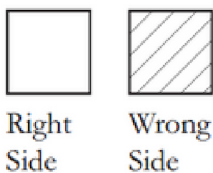

FORMING THE EDGES

On all pieces - with WRONG SIDE facing up measure 2.5cm in from the sides, fold in towards wrong side and press, then fold this in half lengthwise, tucking the edge under itself to create a very pleasing finished line of 1.25cm each side, press again or pin to keep things in place.

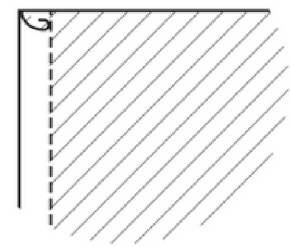
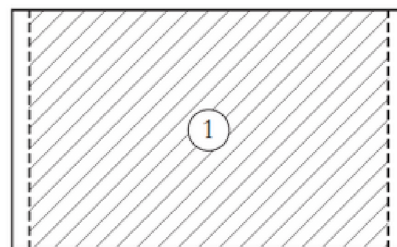
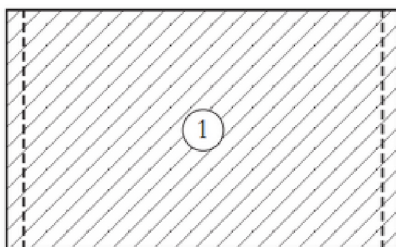

On all pieces - measure 2.5cm from the top line, fold in towards WRONG SIDE and press.
Tuck each corner under as shown and press.
Then tuck whole length under itself for the top line just as you did for the sides and press.
You now have 3 pieces ready to sew.

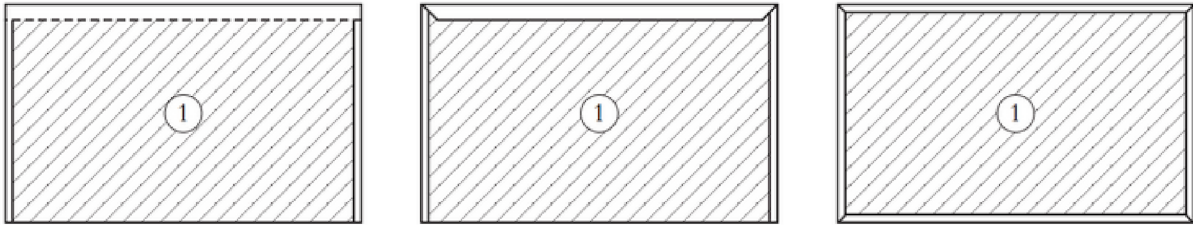

STITCHING THE EDGES

On all pieces, WRONG SIDE UP starting at one corner using straight stitch, sew along the inner edge of your fold lines making sure you go through all layers.
Keep your needle down through the fabric as you get to the mitred corners, lift presser foot, turn fabric ready to stitch the next edge, put presser foot back down and off you go again, repeat until all four edges are stitched, when you reach the corner you started at run a few stitches back and forth to prevent start/ end unravelling.
Secure excess thread.

You now have 3 pieces with all edges stitched.

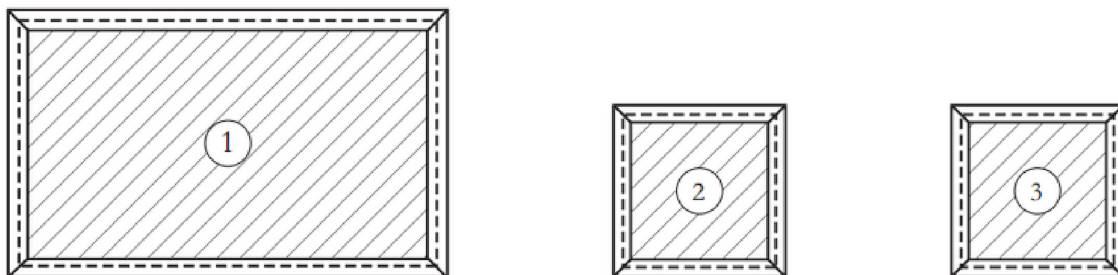

MARKING CENTRAL POINTS

Fold Piece 1 in half, RIGHT SIDE together, putting the short sides together to find the central point of the top and lower long sides. Mark this central point, top and lower, with a pencil mark or pin.

Fold Piece 2 in half by putting sides together, RIGHT SIDE of fabric together. Mark the central point on the lower edge only.

Repeat for Piece 3.

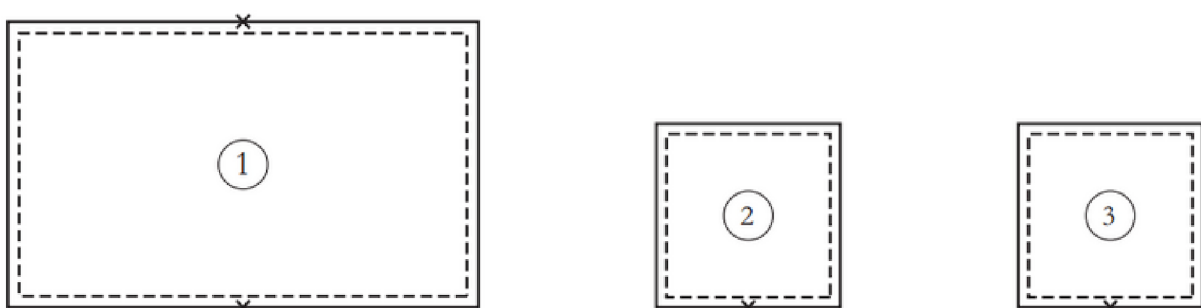

ATTACHING PIECES TOGETHER

Place Piece 1 on flat surface with RIGHT SIDE up.

With RIGHT SIDES together place Piece 2 on top of Piece 1 lining up the centre marks on the top edge of Piece 1 and the lower edge of Piece 2.

Pin together at centre mark and each end of Piece 2 where it lies along the edge of Piece 1. With RIGHT SIDES together place Piece 3 on top of Piece 1 lining up the centre marks on the lower edge of Piece 1 with the lower edge of Piece 3.

Pin together at centre mark and each end of Piece 3 where it lies along the edge of Piece 1.

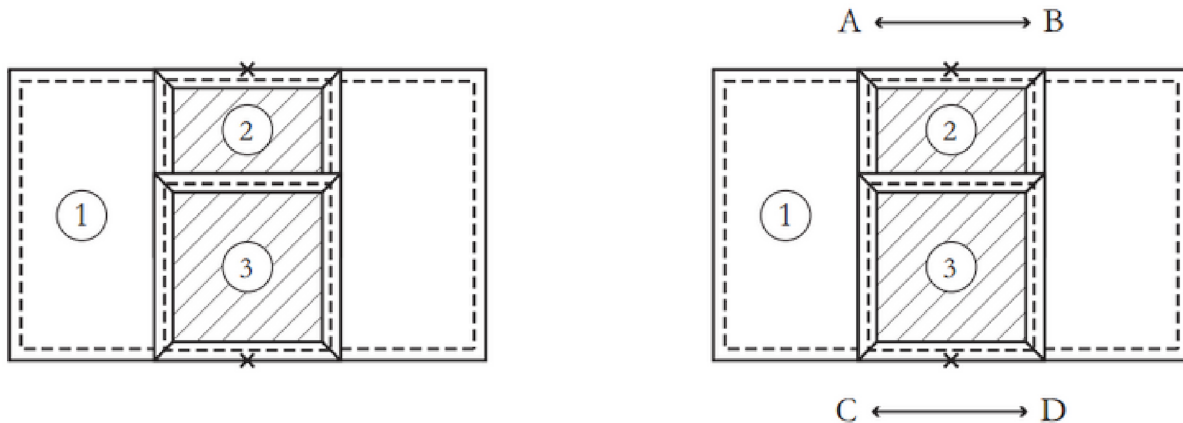

With the edge of fabric lined up with the right hand side of presser foot to help you keep a straight line when sewing, stitch from A to B as shown above with a few reverse stitches at each end to secure stitches.

Cut all loose threads.

Repeat for line C to D.

MARKING UP FOR SHAPING

On a flat surface unfold your work RIGHT SIDE UP, it will look like this with your joining seams underneath.

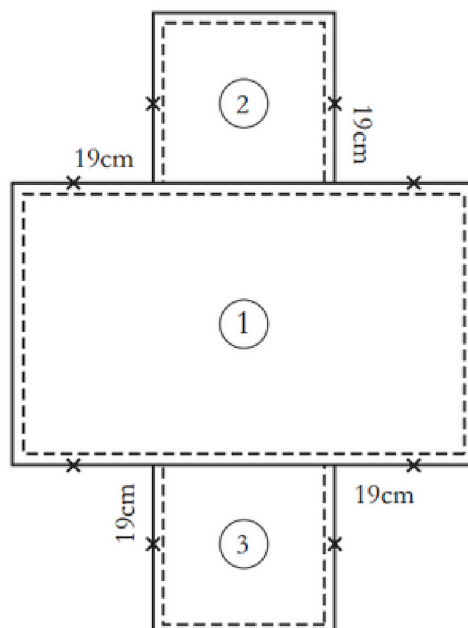

Measure 19cm from the joined corners as shown, mark lightly with a pencil.

FINAL SHAPING

Working on one side at a time align the marked points **RIGHT SIDE** together to form a simple shaped liner.

As before, place the outer edge of your fabric (**WRONG SIDE** facing you) in line with the right hand edge of presser foot, stitch back and forth for a few stitches at each end of this sewn line then cut off excess threads.

Tip - make sure to keep the fabric of Piece 1 out of the way of the these seams.

Repeat for all four shaping sides.

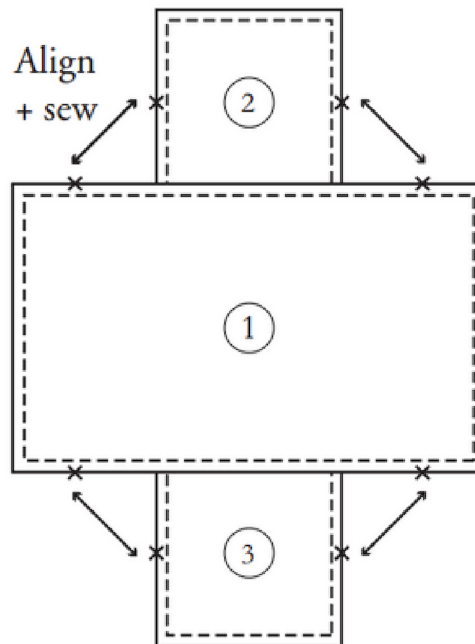

FINISHING

Check over your work for any stray pins or threads.

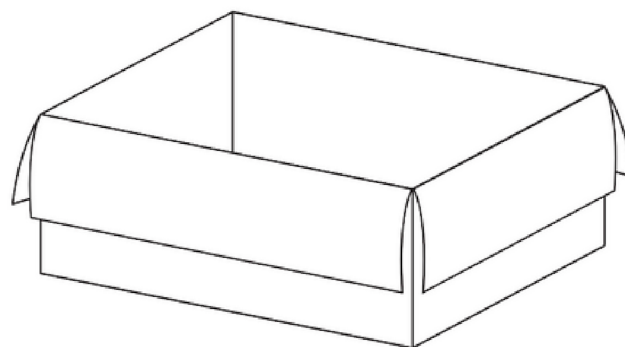

Thank you for making an Abi Cooling Cot Liner and helping us to support baby loss families.

With heartfelt gratitude from Abigail's Footsteps.

www.abigailsfootsteps.co.uk

Copyright Abigail's Footsteps. 2024

This design is copyright and must not be reproduced, re-sold or made for commercial purposes.